



## Leica 3D Disto PROJECTOR in stair case

- when it has to be **right**

**Leica**  
Geosystems

# Projector in stair case

Workflow description:

Measurement → Stair Design → Projection of fixing points

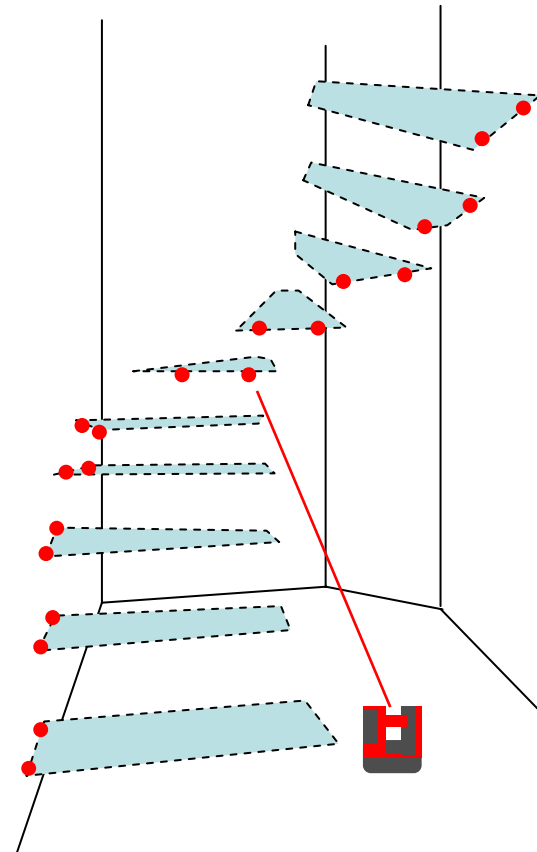

- when it has to be **right**

# Projector in stair case

Preparing the measurement

1

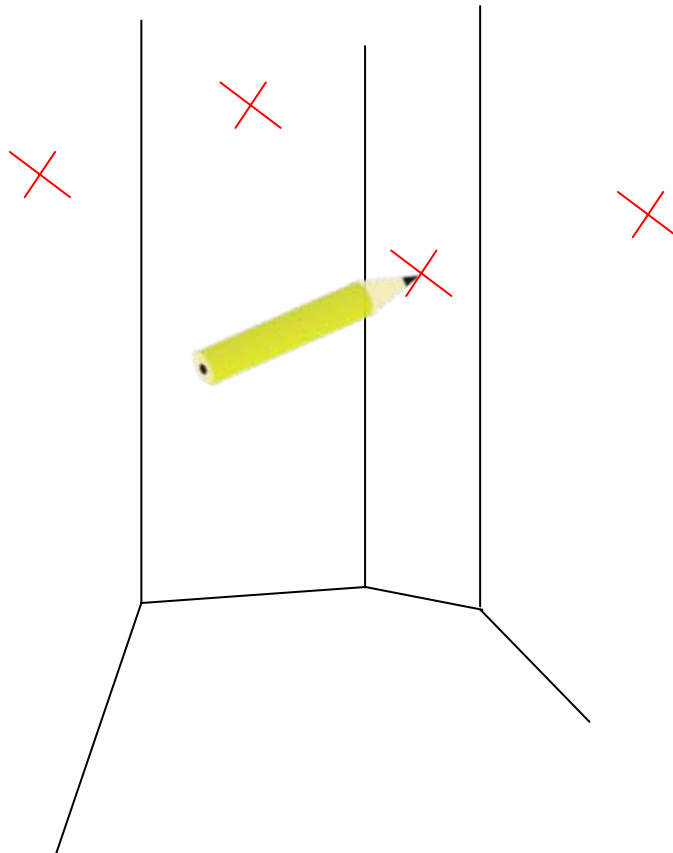

- mark 1 point on each wall of the stair case

- when it has to be **right**

# Projector in stair case

Measurement of existing geometry

2

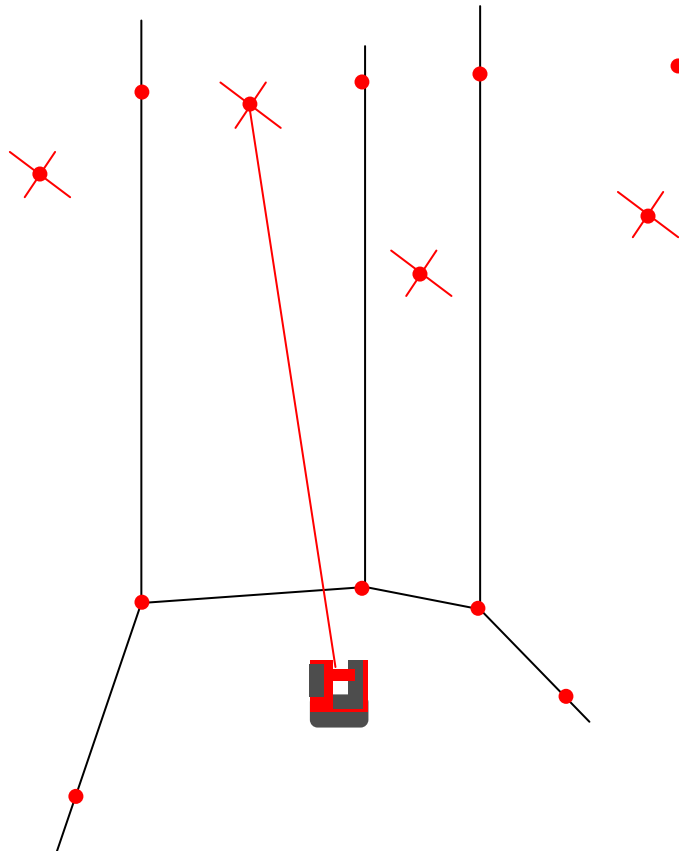

- measure all corners, walls and details of interest with ROOM SCAN application
- measure all your marks

- when it has to be **right**

# Projector in stair case

## Export measurement to CAD

3

- Save the data
- Plug USB stick to Control Unit
- Start „File Manager“, select file, press „export“ key
- Import to your CAD system.

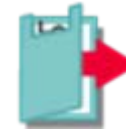

- when it has to be **right**

# Projector in stair case

CAD

4

- Design the stair and the fixing points in CAD

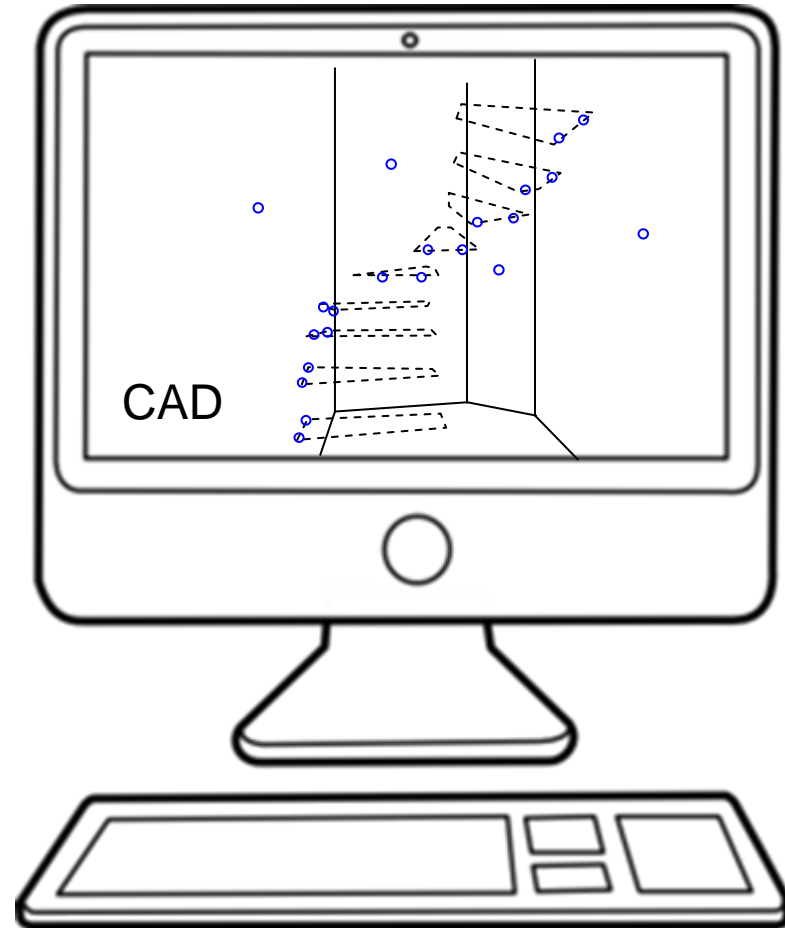

- when it has to be **right**

# Projector in stair case

Export CAD design data

5

- Export 1 file for each wall. The marked point of each wall must be in the file, too. Accepted file format is DXF or CSV
- Copy the files to the „import“ folder on the USB stick

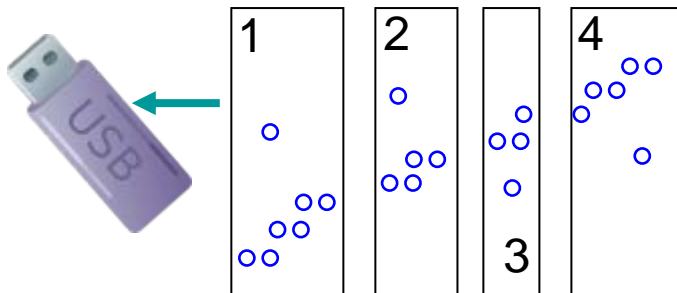
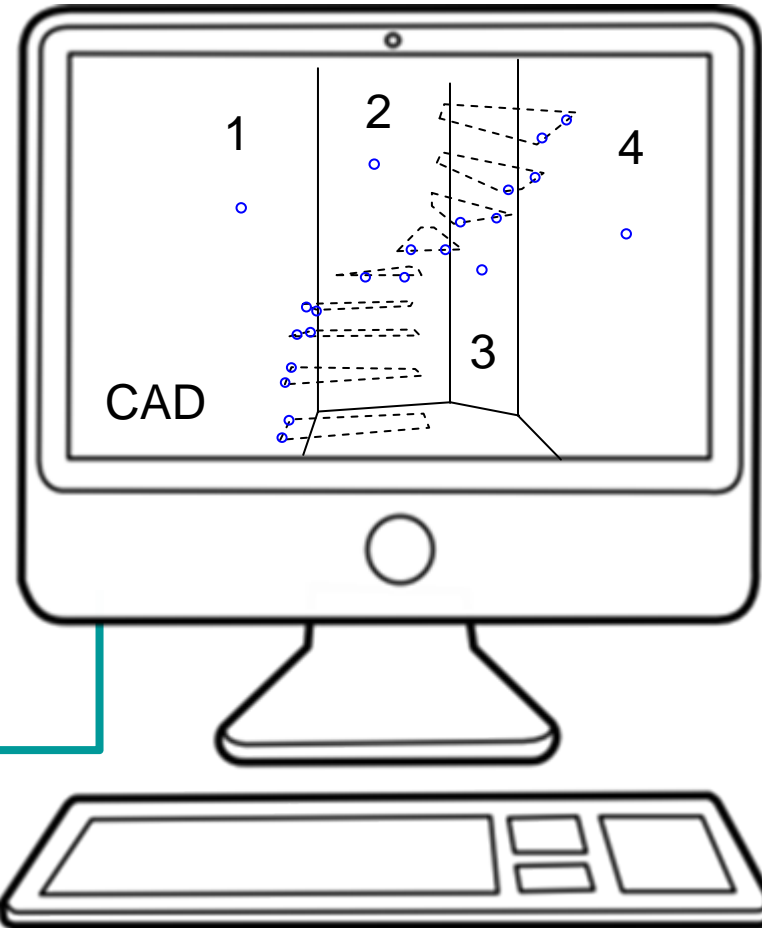

- when it has to be **right**

# Projector in stair case

Copy design data to memory of Control Unit

6



- Plug USB stick to Control Unit
- Start „File Manager“
- Go to 2nd toolbar
- Press „import“ key
- Select a design file; use the viewer
- Press checkmark to import the file
- Repeat with all design files



- when it has to be **right**



# Projector in stair case

Choose working area

7

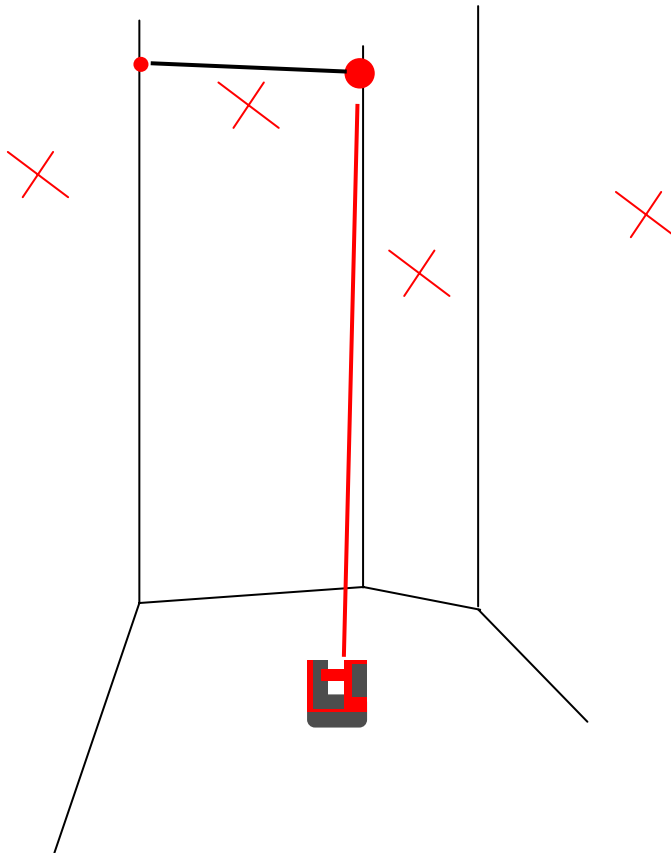

- Start Projector application

- select option ,vertical'

- assistant prompts how to proceed

- Measure 2 points on the wall

- press checkmark key

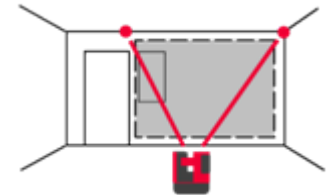
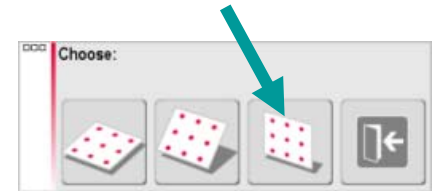

- when it has to be **right**

# Projector in stair case

Measure the mark

8

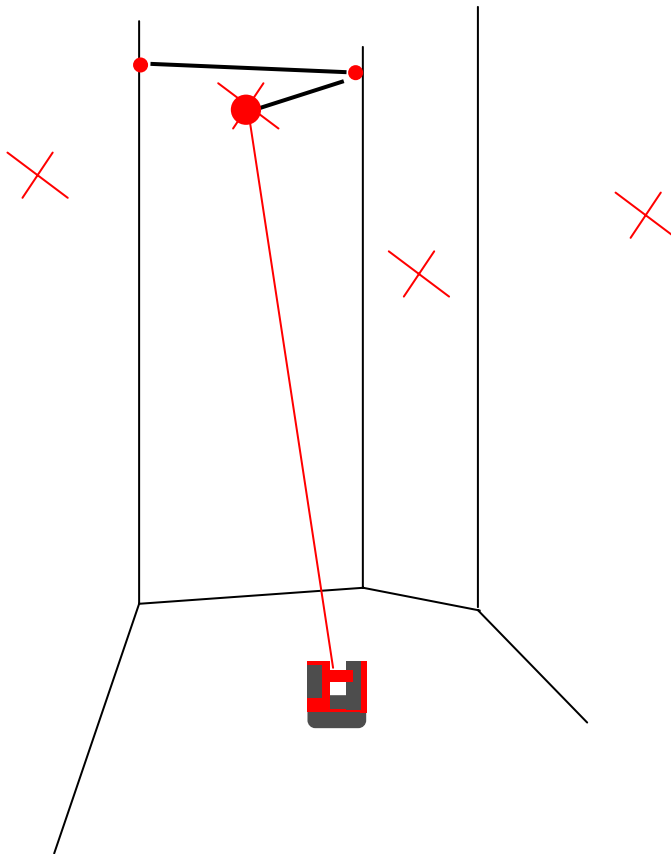

- assistant prompts how to proceed
- measure the marked point
- (if you want, you can delete the unnecessary line via CUT LINE key)
- Press checkmark

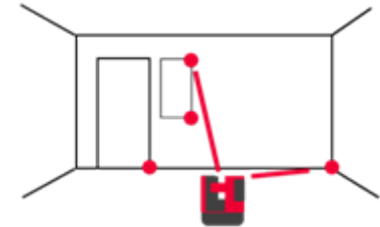

- when it has to be **right**

# Projector in stair case

Import design data

9

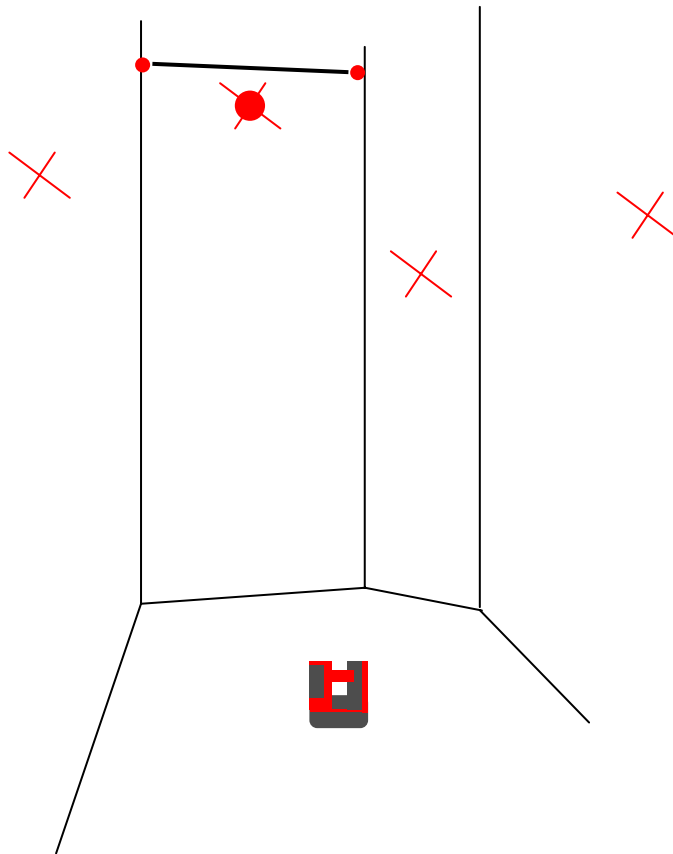

- Choose data source option IMPORT

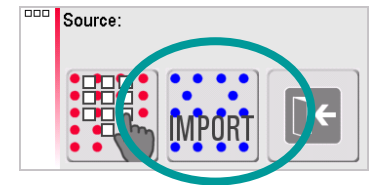

- Select the design file that corresponds to the wall (use viewer to check)



- Press checkmark



- when it has to be **right**

# Projector in stair case

Adjust design points on the screen (1)

9

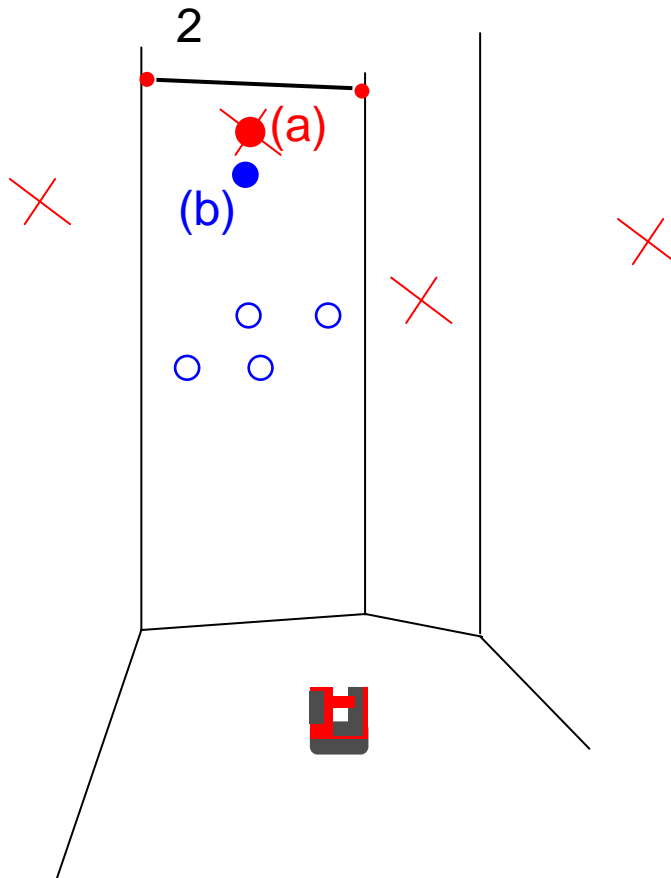

- blue design points appear on the screen

## ON SCREEN:

- tip on red point of measured mark (a)
- tip on the corresponding blue design point (b)

(both points must be highlighted)

- when it has to be **right**

# Projector in stair case

Adjust design points on the screen (2)

10

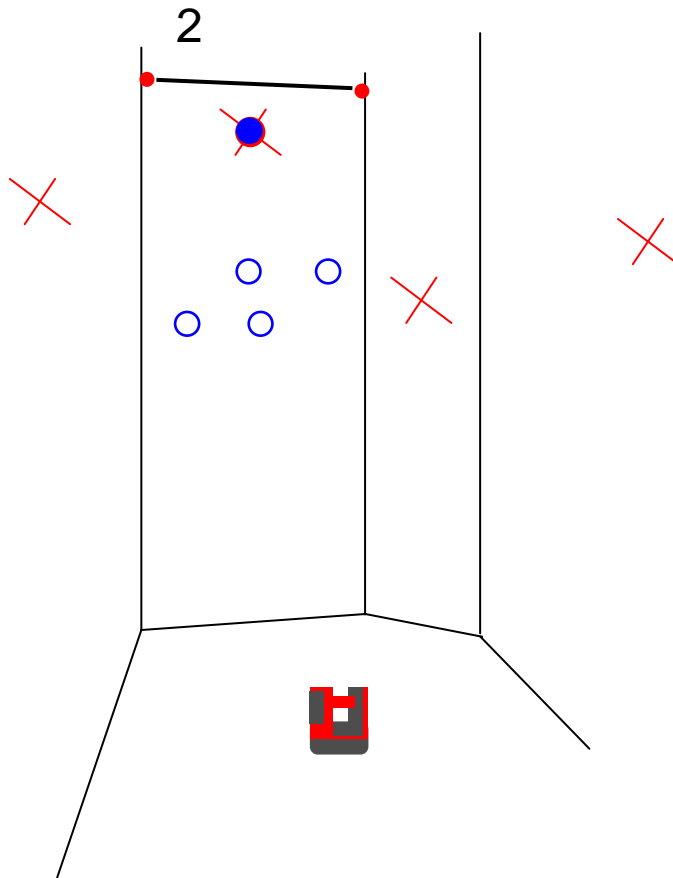

## ON SCREEN:

- press COVER key
- design points move to the correct position
- press checkmark



- when it has to be **right**

# Projector in stair case

Projection of design points

11

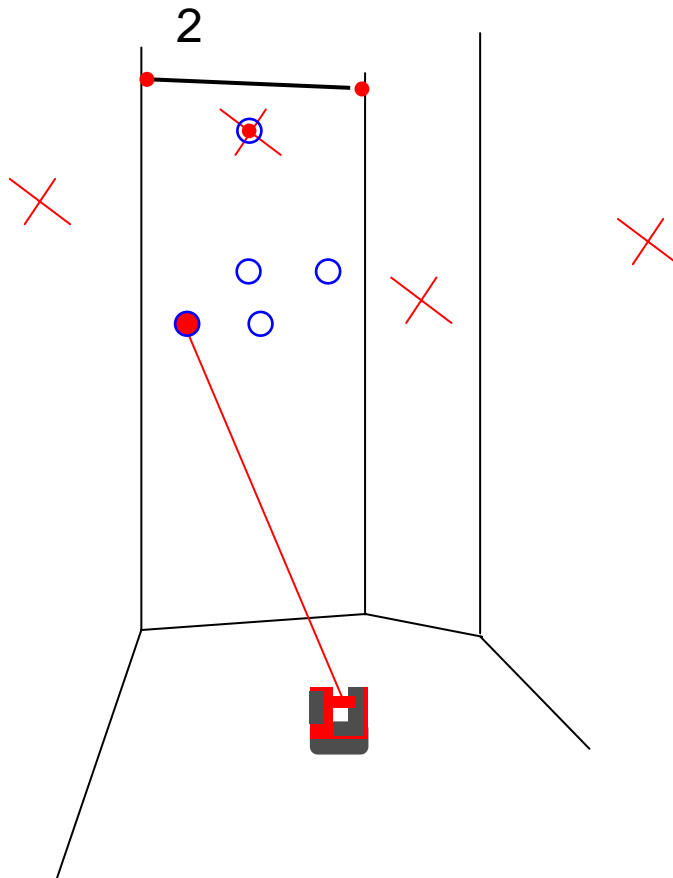

## ON SCREEN:

- tip/select a design point  
OR
- use arrow keys for selection
- press DIST → laser beam indicates position precisely. Point is found if the laser blinks.



- when it has to be **right**

# Projector in stair case

Projection of design points

12

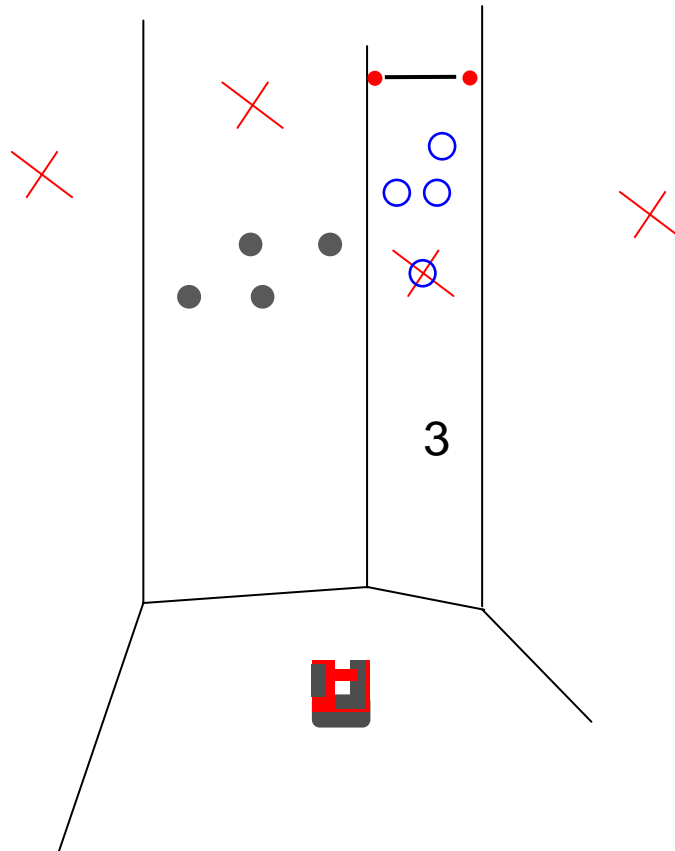

Restart PROJECTOR application and repeat workflow on the other walls

- when it has to be **right**

# Projector in stair case

Additional advices:

- Accuracy on uneven surfaces
- How to increase security and accuracy
- Workflow on curved or polygonal surfaces

- when it has to be **right**



# Projector in stair case

Accuracy on uneven surfaces

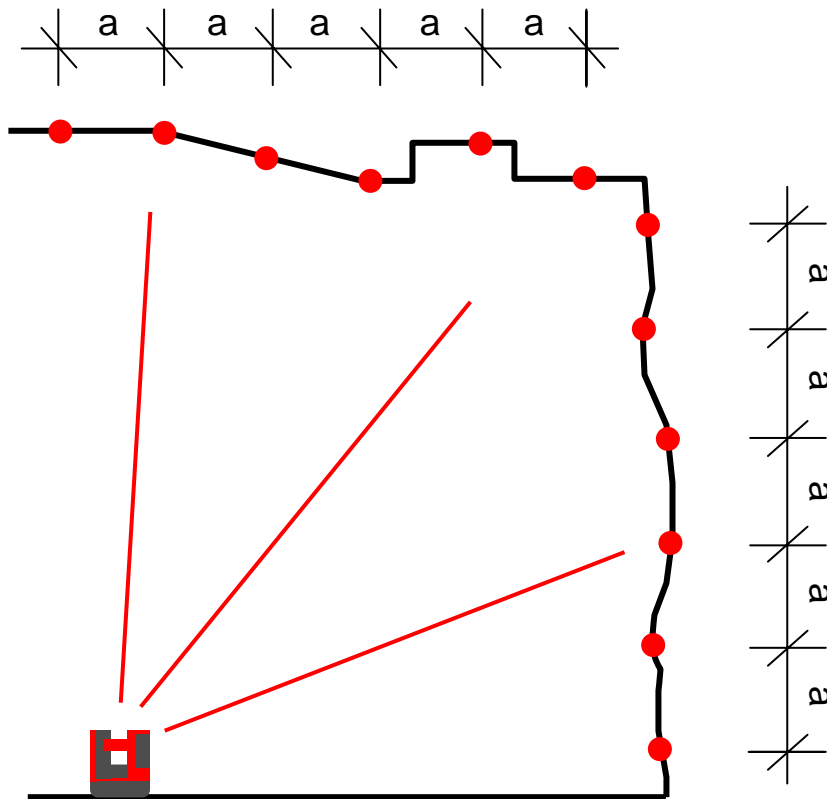

Uneven surfaces are no problem. Projector indicates all points precisely and error-free!

- when it has to be **right**

# Projector in stair case

Increase security and accuracy with more marked points

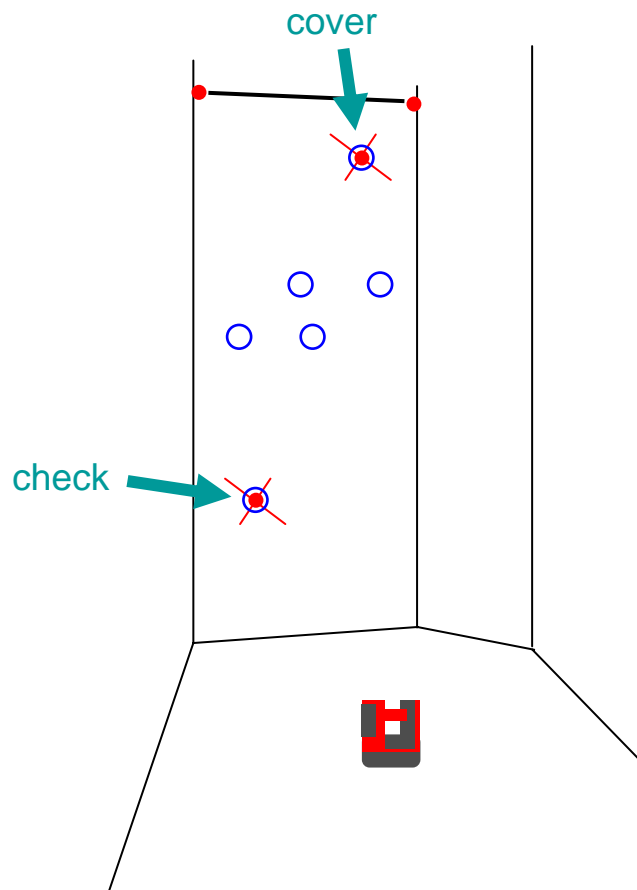

If you mark two points on each wall you have a control check for the correct position of the design points:

- cover measured mark and design point as described before
- then select the second pair of points and check the indicated distance → it should be „0“
- continue



- when it has to be **right**

# Projector in stair case

Workflow on curved or polygonal surfaces

1

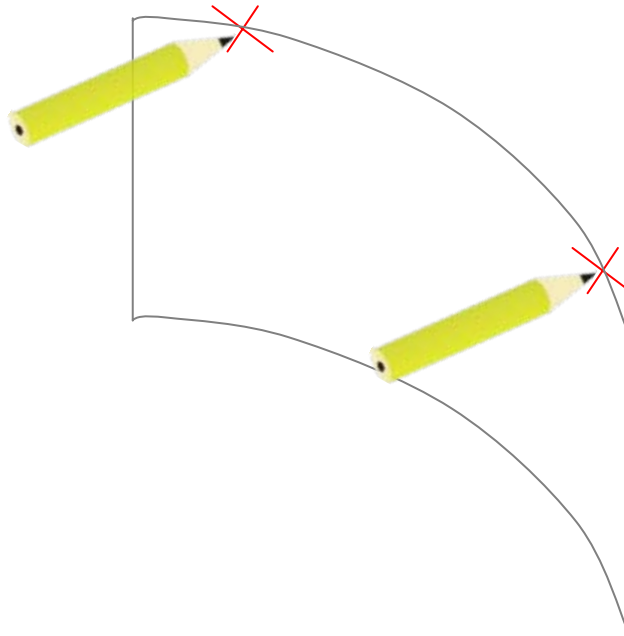

Mark 2 points  
approximately on the  
same level on the  
working area

- when it has to be **right**

# Projector in stair case

Workflow on curved or polygonal surfaces

2

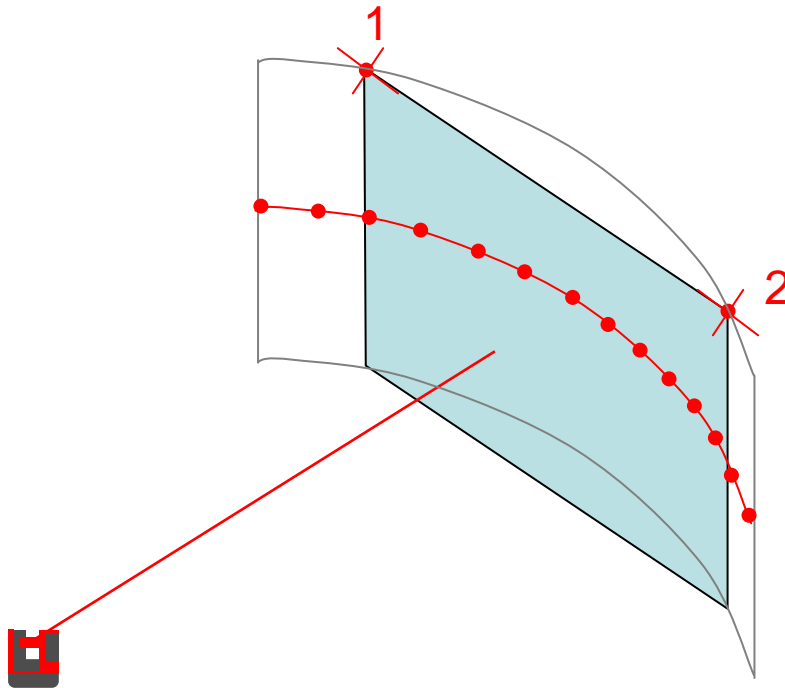

- Start Room Scan application
- Measure all you need to design the stairs
- Don't forget to measure both marks
- Save and export the data

- when it has to be **right**

# Projector in stair case

Workflow on curved or polygonal surfaces

4

- Design the stair and the fixing points in CAD

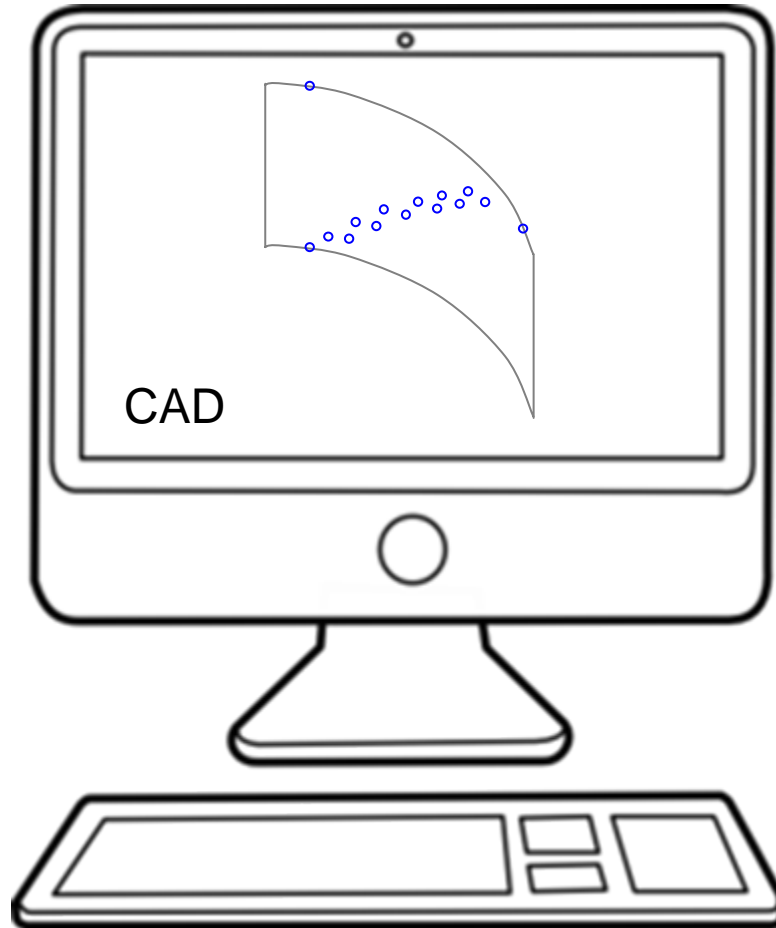

- when it has to be **right**

# Projector in stair case

Workflow on curved or polygonal surfaces

4

Transform all points onto a vertical plane through both marks

That distorts the geometry but points will be at correct position if projected on the bulge.

Export data to DXF file (drawing) or CSV file (chart).

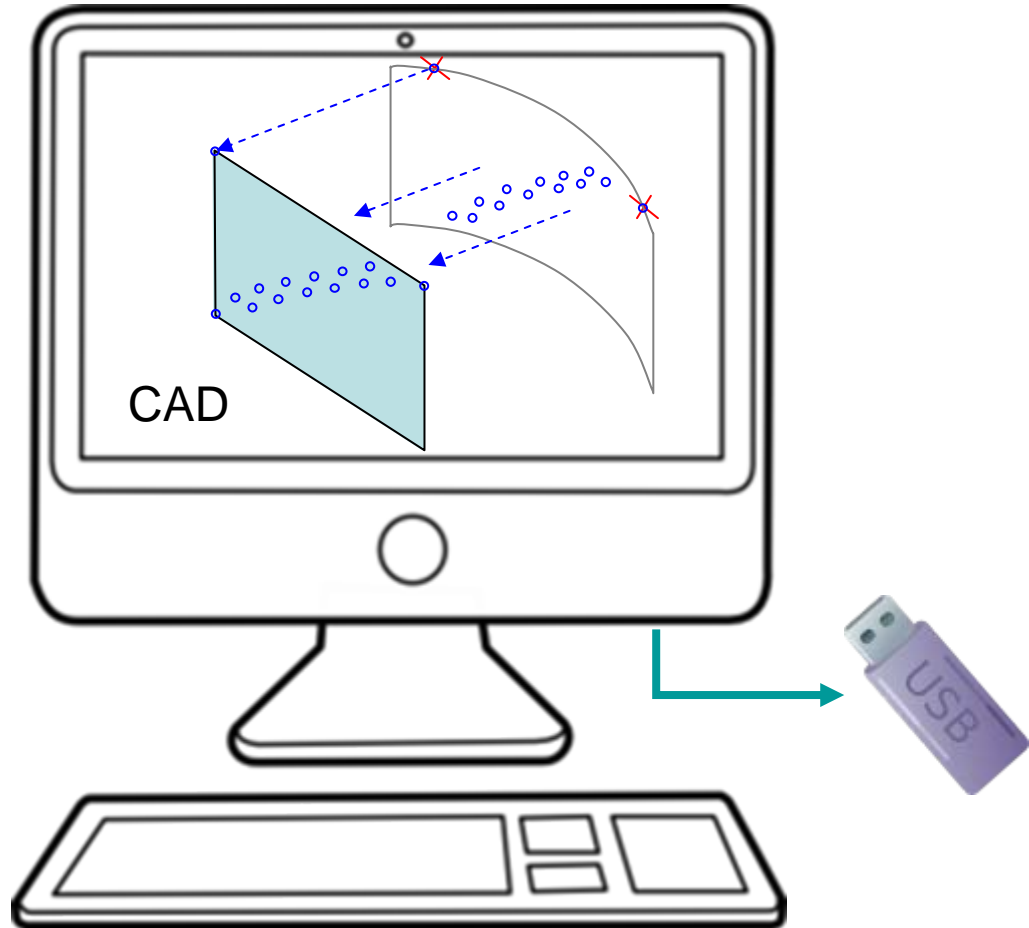

- when it has to be **right**

# Projector in stair case

Workflow on curved or polygonal surfaces

5

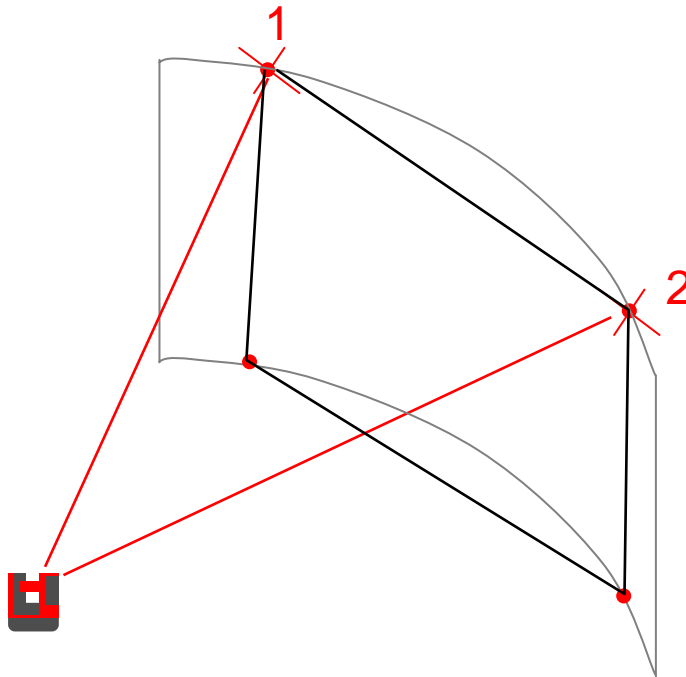

- Import data to Control Unit
- Start Projector ,vertical'
- Measure the existing marks first, further points if necessary
- Import the design file

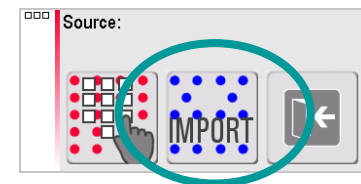
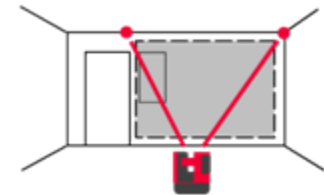
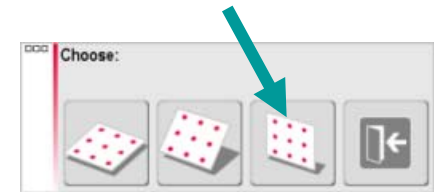

- when it has to be **right**

# Projector in stair case

Workflow on curved or polygonal surfaces

6

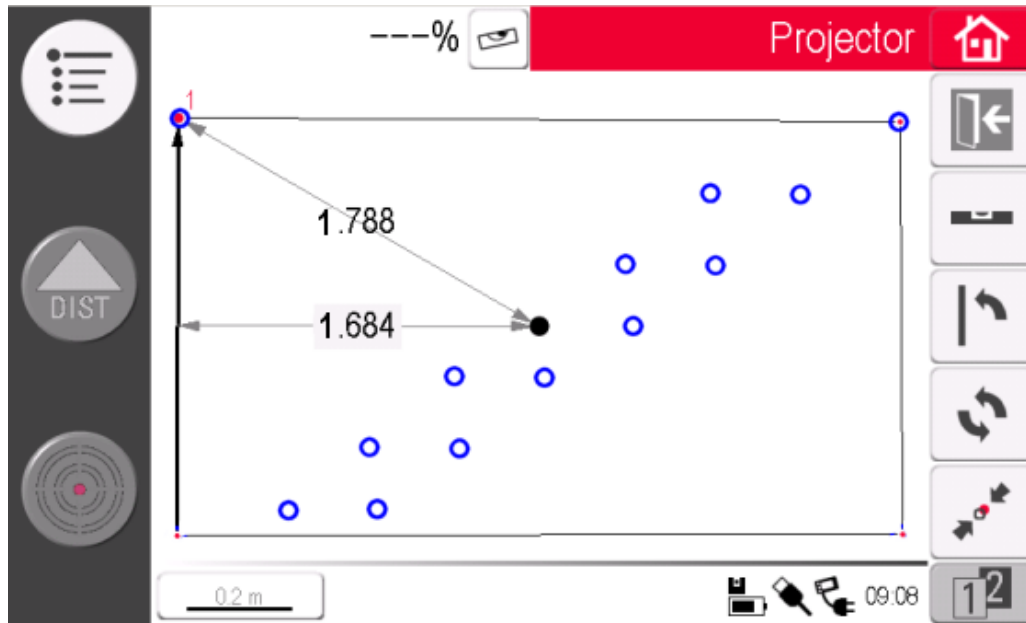

- Cover the corner points and measured points (use COVER key)
- Check correct position (click on points and lines → dimensions appear)
- Press checkmark if ok



- when it has to be **right**



# Projector in stair case

Workflow on curved or polygonal surfaces

7

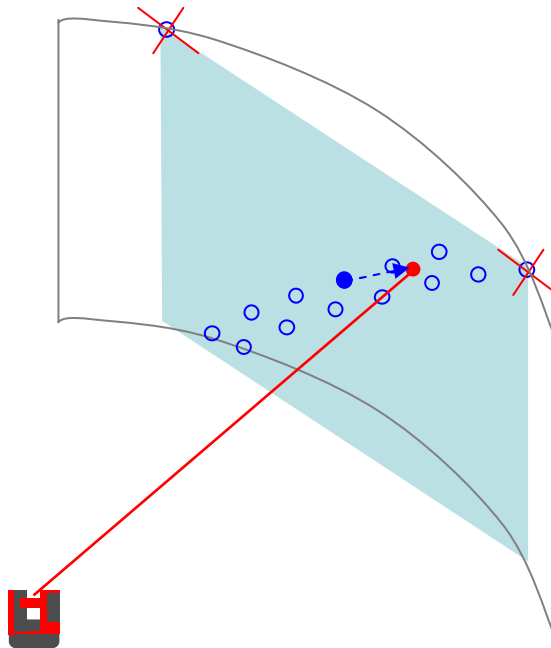

Set out like usual. Points are projected to the correct position on the curved surface.

- when it has to be **right**

# Projector in stair case

Workflow on curved or polygonal surfaces

8

After each point's projection the distance to the plane is indicated. In the sketch the projected point is 0.684 m behind the plane.

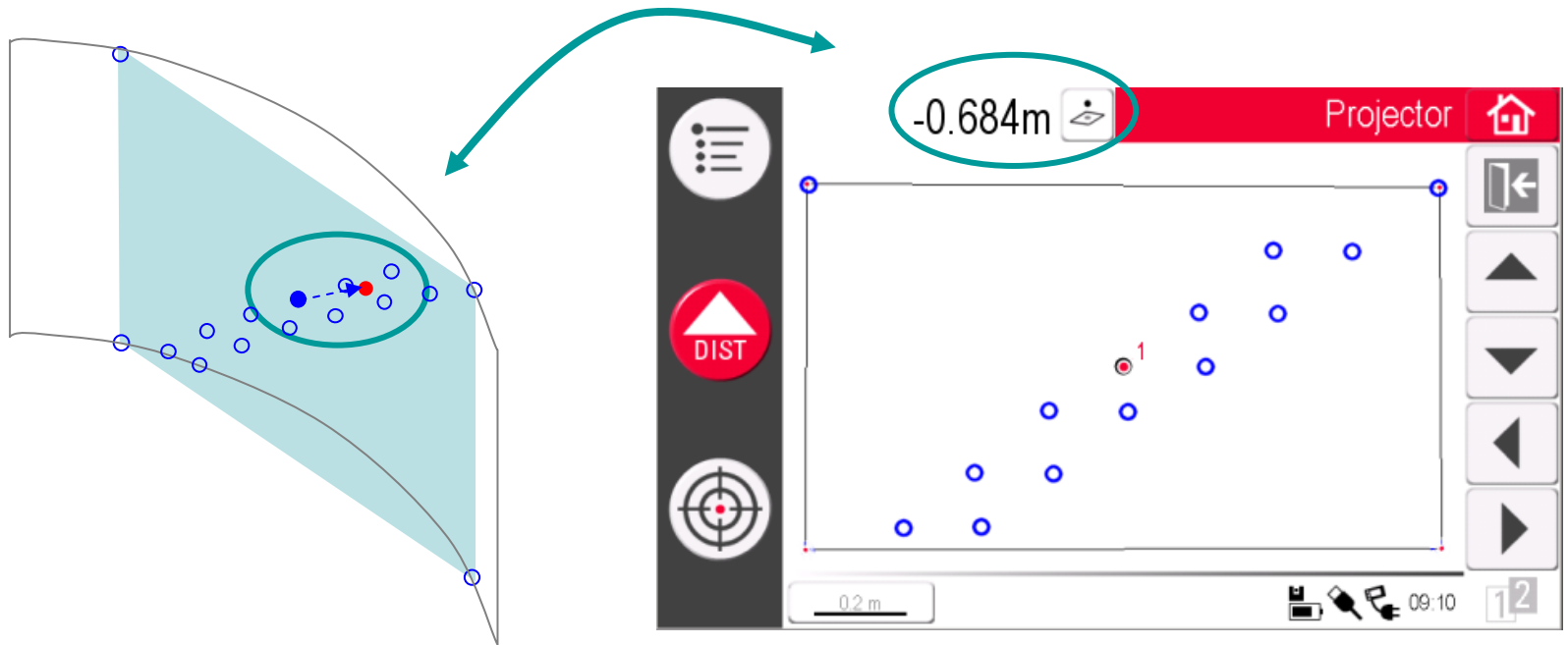

- when it has to be **right**

# myworld

## Further tutorials for download

If you register at myWorld@Leica Geosystems you will have access to a wide range of services, information and training material:

- warranty extension
- tutorials
- software updates
- support
- manuals
- ...
- ...

<https://myworld.leica-geosystems.com>  
[www.3ddisto.com](http://www.3ddisto.com)

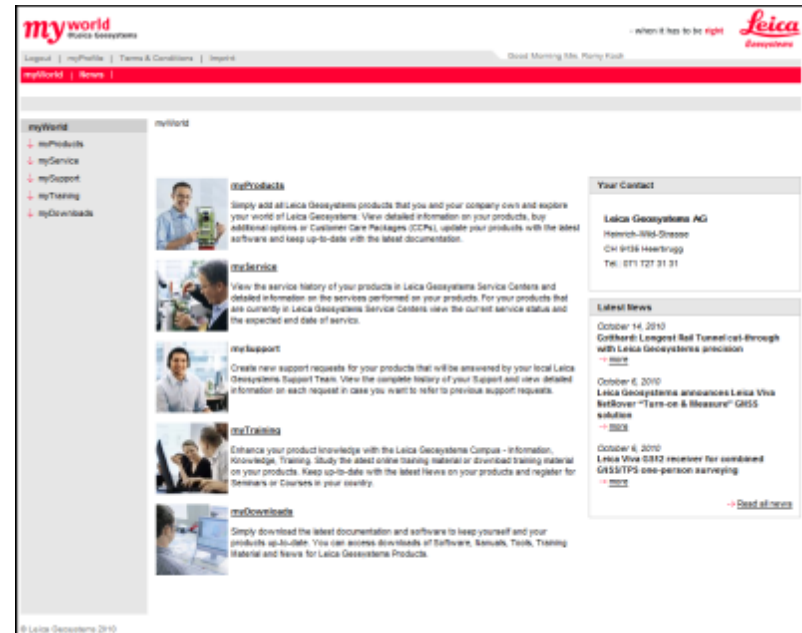

- when it has to be **right**

**Leica**  
Geosystems